



UNIVERSITY OF CAMBRIDGE INTERNATIONAL EXAMINATIONS
General Certificate of Education
Advanced Subsidiary Level and Advanced Level

PHYSICS

9702/13

Paper 1 Multiple Choice

October/November 2012

1 hour

Additional Materials: Multiple Choice Answer Sheet
Soft clean eraser
Soft pencil (type B or HB is recommended)



READ THESE INSTRUCTIONS FIRST

Write in soft pencil.

Do not use staples, paper clips, highlighters, glue or correction fluid.

Write your name, Centre number and candidate number on the Answer Sheet in the spaces provided unless this has been done for you.

There are **forty** questions on this paper. Answer **all** questions. For each question there are four possible answers **A, B, C** and **D**.

Choose the **one** you consider correct and record your choice in **soft pencil** on the separate Answer Sheet.

Read the instructions on the Answer Sheet very carefully.

Each correct answer will score one mark. A mark will not be deducted for a wrong answer.
Any working should be done in this booklet.

This document consists of **27** printed pages and **1** blank page.



Data

speed of light in free space,	$c = 3.00 \times 10^8 \text{ m s}^{-1}$
permeability of free space,	$\mu_0 = 4\pi \times 10^{-7} \text{ H m}^{-1}$
permittivity of free space,	$\epsilon_0 = 8.85 \times 10^{-12} \text{ F m}^{-1}$ $(\frac{1}{4\pi\epsilon_0} = 8.99 \times 10^9 \text{ m F}^{-1})$
elementary charge,	$e = 1.60 \times 10^{-19} \text{ C}$
the Planck constant,	$h = 6.63 \times 10^{-34} \text{ J s}$
unified atomic mass constant,	$u = 1.66 \times 10^{-27} \text{ kg}$
rest mass of electron,	$m_e = 9.11 \times 10^{-31} \text{ kg}$
rest mass of proton,	$m_p = 1.67 \times 10^{-27} \text{ kg}$
molar gas constant,	$R = 8.31 \text{ J K}^{-1} \text{ mol}^{-1}$
the Avogadro constant,	$N_A = 6.02 \times 10^{23} \text{ mol}^{-1}$
the Boltzmann constant,	$k = 1.38 \times 10^{-23} \text{ J K}^{-1}$
gravitational constant,	$G = 6.67 \times 10^{-11} \text{ N m}^2 \text{ kg}^{-2}$
acceleration of free fall,	$g = 9.81 \text{ m s}^{-2}$

Formulae

uniformly accelerated motion,	$s = ut + \frac{1}{2}at^2$ $v^2 = u^2 + 2as$
work done on/by a gas,	$W = p\Delta V$
gravitational potential,	$\phi = -\frac{Gm}{r}$
hydrostatic pressure,	$p = \rho gh$
pressure of an ideal gas,	$p = \frac{1}{3}\frac{Nm}{V}\langle c^2 \rangle$
simple harmonic motion,	$a = -\omega^2 x$
velocity of particle in s.h.m.,	$v = v_0 \cos \omega t$ $v = \pm \omega \sqrt{x_0^2 - x^2}$
electric potential,	$V = \frac{Q}{4\pi\epsilon_0 r}$
capacitors in series,	$1/C = 1/C_1 + 1/C_2 + \dots$
capacitors in parallel,	$C = C_1 + C_2 + \dots$
energy of charged capacitor,	$W = \frac{1}{2}QV$
resistors in series,	$R = R_1 + R_2 + \dots$
resistors in parallel,	$1/R = 1/R_1 + 1/R_2 + \dots$
alternating current/voltage,	$x = x_0 \sin \omega t$
radioactive decay,	$x = x_0 \exp(-\lambda t)$
decay constant,	$\lambda = \frac{0.693}{t_{\frac{1}{2}}}$

1 The units of all physical quantities can be expressed in terms of SI base units.

Which pair contains quantities with the same base units?

- A force and momentum
- B pressure and Young modulus
- C power and kinetic energy
- D mass and weight

2 Two physical quantities P and Q are added. The sum of P and Q is R , as shown.

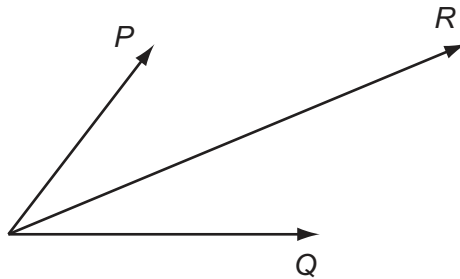

Which quantity could be represented by P and by Q ?

- A kinetic energy
- B power
- C speed
- D velocity

Space for working

- 3 A 1.5V cell supplies 0.20A to a lamp for seven hours before the lamp goes out.

What is a sensible estimate for the initial chemical energy content of the cell?

- A 1×10^2 J B 1×10^4 J C 1×10^6 J D 1×10^8 J

- 4 Three of these quantities have the same unit.

Which quantity has a different unit?

- A $\frac{\text{energy}}{\text{distance}}$
 B force
 C power \times time
 D rate of change of momentum

- 5 A cathode-ray oscilloscope displays a square wave, as shown in the diagram.

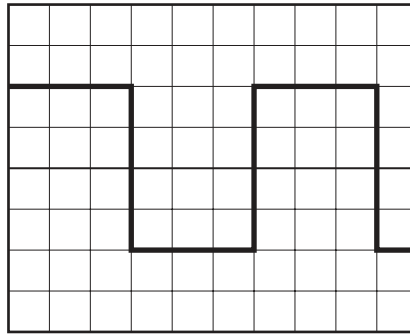

The time-base setting is 0.20 ms per division.

What is the frequency of the square wave?

- A 8.3 Hz B 830 Hz C 1300 Hz D 1700 Hz

Space for working

- 6 What will reduce the systematic errors when taking a measurement?
- A adjusting the needle on a voltmeter so that it reads zero when there is no potential difference across it
 - B measuring the diameter of a wire at different points and taking the average
 - C reducing the parallax effects by using a marker and a mirror when measuring the amplitude of oscillation of a pendulum
 - D timing 20 oscillations, rather than a single oscillation, when finding the period of a pendulum
- 7 In an experiment to determine the acceleration of free fall g , the time t taken for a ball to fall through distance s was measured. The uncertainty in the measurement of s is estimated to be 2%. The uncertainty in the measurement of t is estimated to be 3%.

The value of g is determined using the equation

$$g = \frac{2s}{t^2}.$$

What is the uncertainty in the calculated value of g ?

- A 1% B 5% C 8% D 11%

Space for working

- 8 A bicycle brakes so that it undergoes uniform deceleration from a speed of 8 m s^{-1} to 6 m s^{-1} over a distance of 7 m.

If the deceleration of the bicycle remains constant, what further distance will it travel before coming to rest?

- A 7 m B 9 m C 16 m D 21 m

- 9 A ball is released from rest above a horizontal surface. It bounces once and is caught.

Which graph represents the variation with time t of the velocity v of the ball?

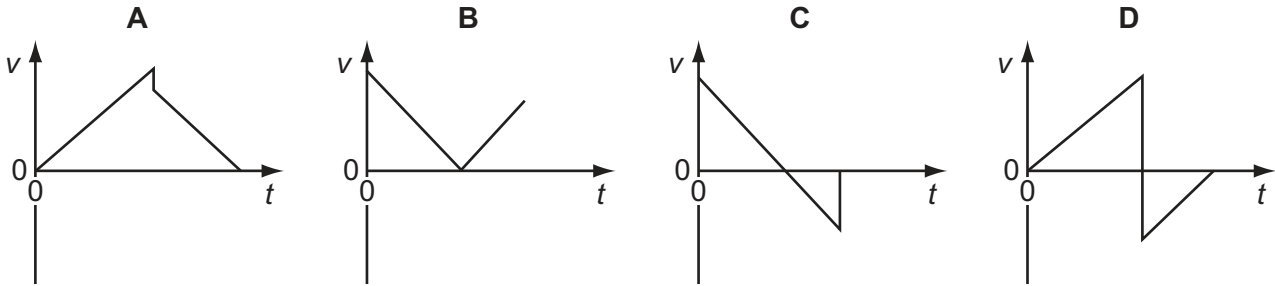

Space for working

10 A mass on the end of a spring bounces up and down as shown, after being released at time $t = 0$.

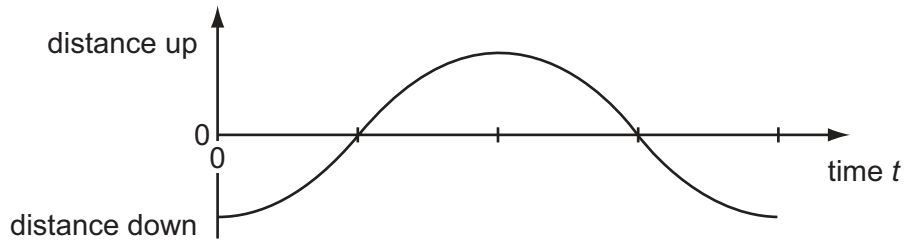

Which graph shows how the velocity varies with time?

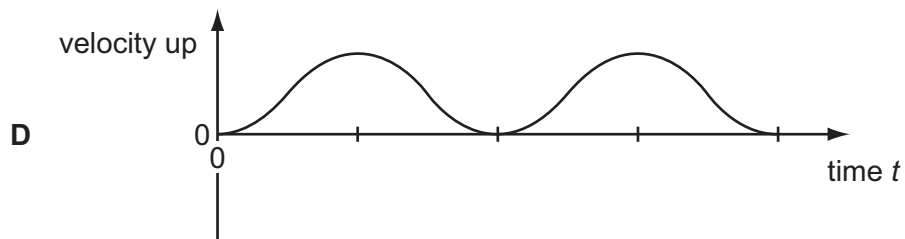
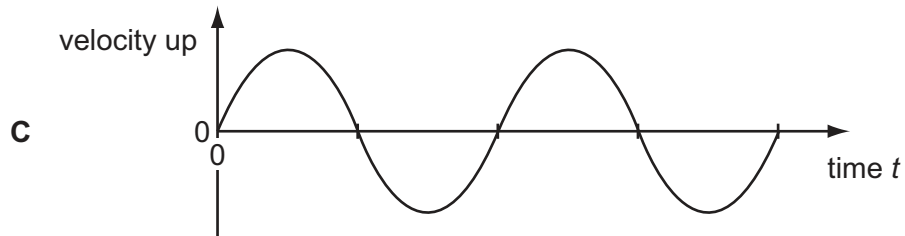
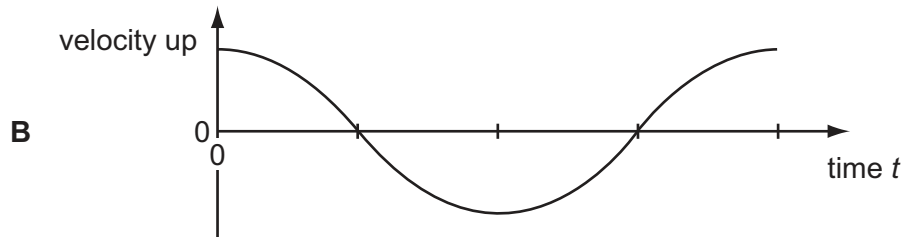
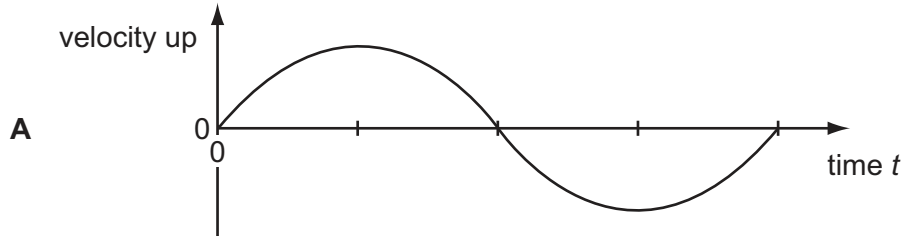

Space for working

- 11 The diagram shows two spherical masses approaching each other head-on at an equal speed u . One is of mass m and the other of mass $2m$.



Which diagram, showing the situation after the collision, is **not** consistent with the principle of conservation of momentum?

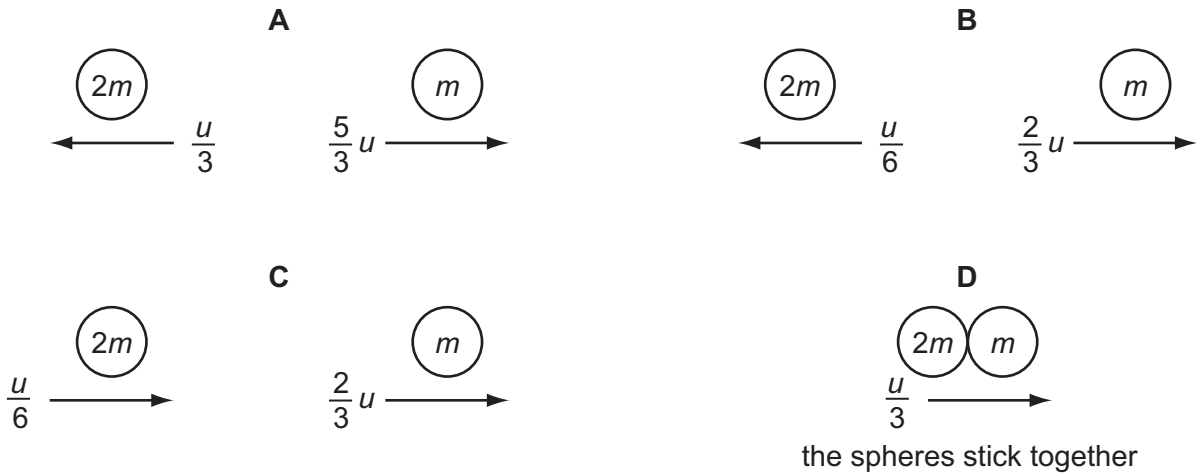

Space for working

- 12 A molecule of mass m travelling at speed v hits a wall in a direction perpendicular to the wall. The collision is elastic.

What are the changes in the kinetic energy and in the momentum of the molecule caused by the collision?

	change in momentum	change in kinetic energy
A	0	0
B	0	mv^2
C	$2mv$	0
D	mv^2	0

- 13 The IKAROS satellite has mass 320 kg and moves through space using a solar sail of area 20 m^2 . The average solar wind pressure is $1.0 \times 10^{-5}\text{ N m}^{-2}$.

What is the acceleration of the satellite caused by the solar wind?

- A** $3.1 \times 10^{-8}\text{ m s}^{-2}$
B $6.3 \times 10^{-7}\text{ m s}^{-2}$
C $3.2 \times 10^{-3}\text{ m s}^{-2}$
D $6.4 \times 10^{-2}\text{ m s}^{-2}$

Space for working

14 The graph shows the momentum of a cyclist over a period of 8.0 s.

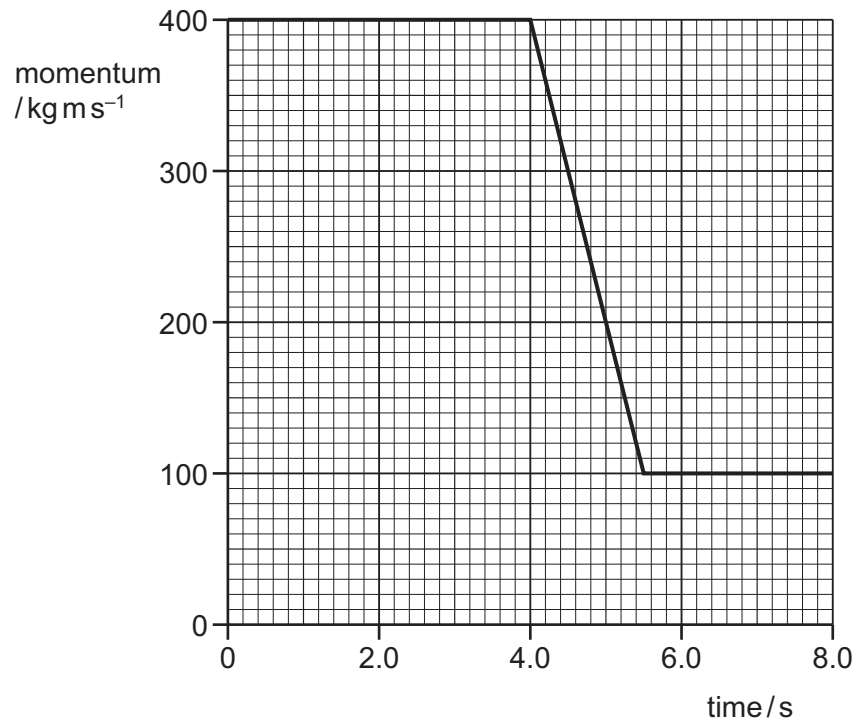

At time 4.0 s, she applies the brakes.

What is the resultant force on the cyclist during the period when the brakes are applied?

- A** 55 N **B** 200 N **C** 270 N **D** 450 N

Space for working

- 15 A hailstone, initially stationary at the base of a cloud, falls vertically towards the Earth. The diagram shows the magnitudes and directions of the forces acting on the hailstone as it starts to drop.

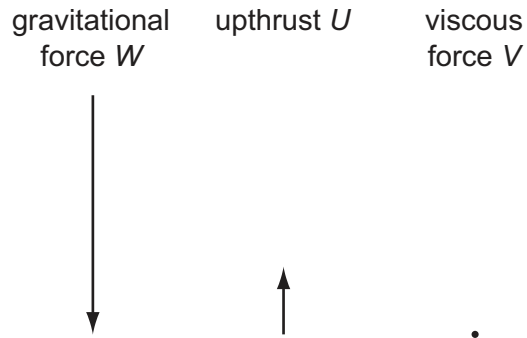

Which diagram shows the magnitudes and directions of these forces when the hailstone attains a terminal (constant) speed in the air (of uniform density)?

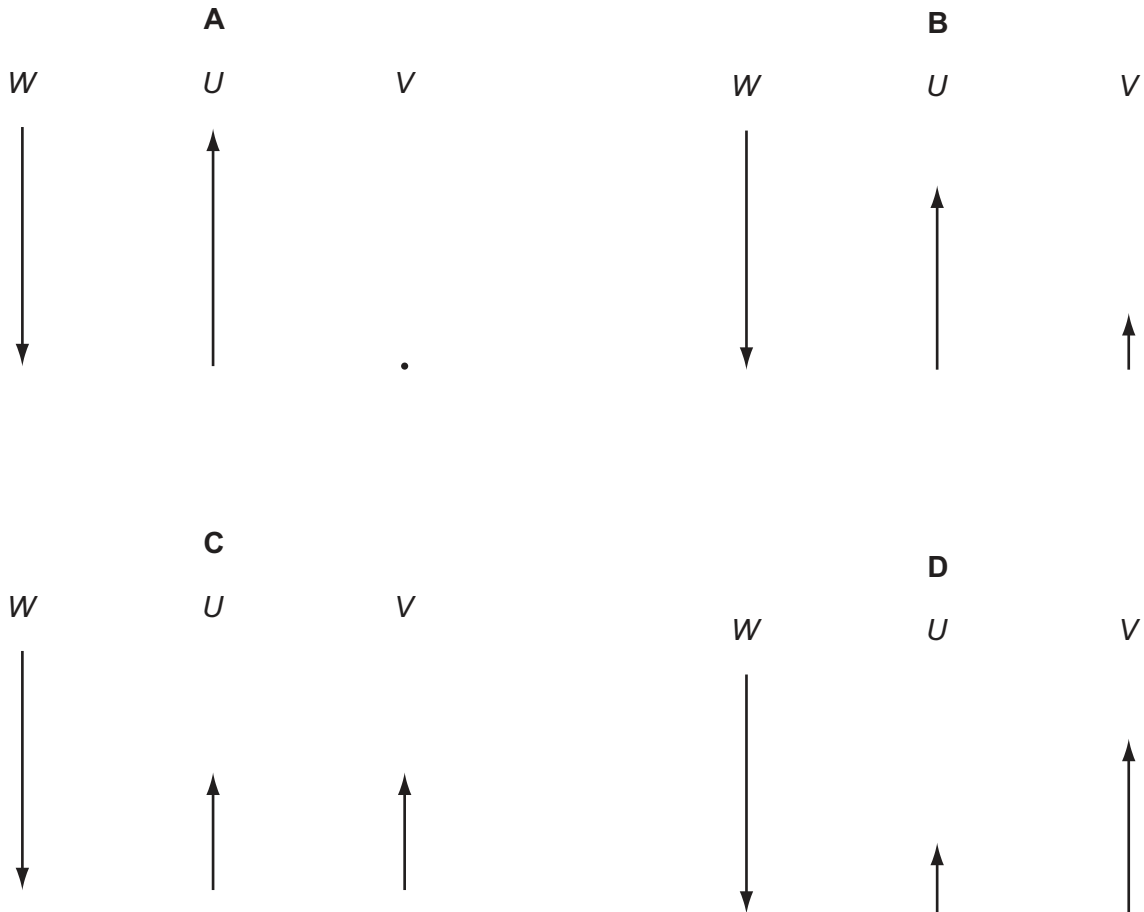

Space for working

16 Four beams of the same length each have three forces acting on them.

Which beam has both zero resultant force and zero resultant torque acting?

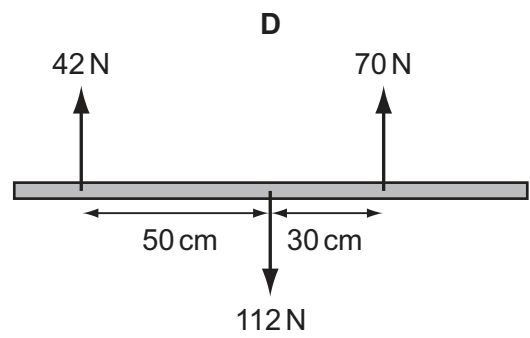
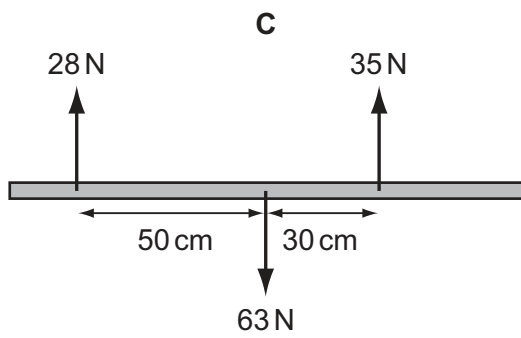
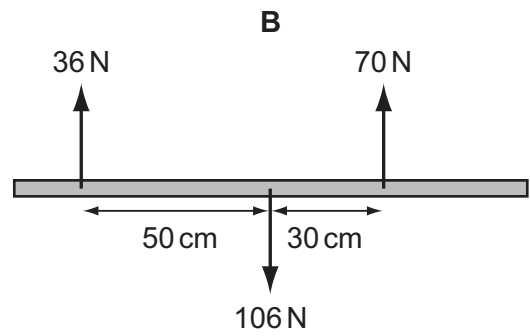
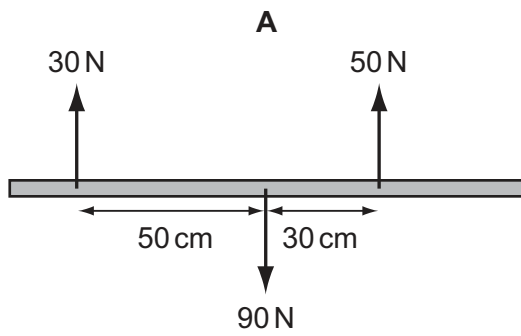

Space for working

17 The diagrams show the forces acting on different bodies.

Which body **cannot** be in equilibrium?

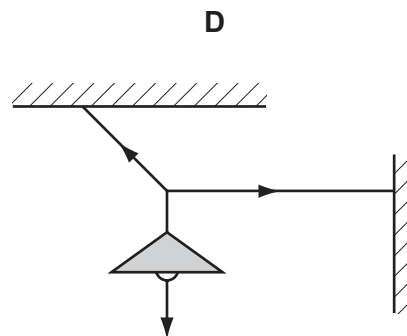
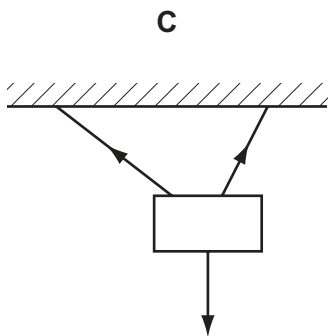
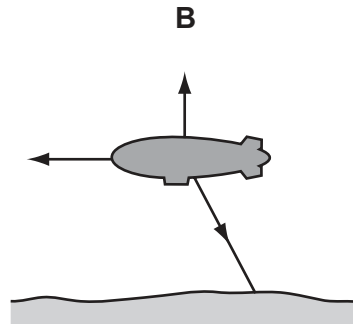
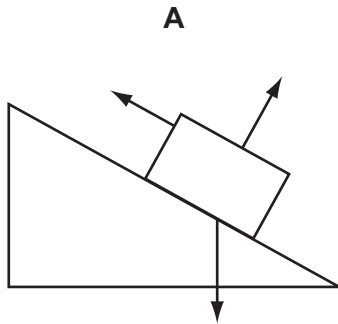

18 A car travelling with speed 28 m s^{-1} leaves a motorway on an exit road. The end of the exit road is 22 m higher than the motorway.

If only the force of gravity is considered, what will be the speed of the car at the end of the exit road?

- A** 7.3 m s^{-1} **B** 19 m s^{-1} **C** 21 m s^{-1} **D** 24 m s^{-1}

Space for working

- 19 A piston in a gas supply pump has an area of 400 cm^2 and it moves a distance of 25 cm during one stroke.

The pump moves the gas against a fixed pressure of 3000 Pa.

How much work is done by the piston during one stroke?

- A 30 J B $3.0 \times 10^3 \text{ J}$ C $3.0 \times 10^5 \text{ J}$ D $3.0 \times 10^7 \text{ J}$
- 20 A transformer has the following input and output.

	potential difference / V	current / A
input	11 000	28
output	240	1200

What is the efficiency of the transformer?

- A 0.94% B 1.0% C 11% D 94%

Space for working

21 The diagram shows a hydroelectric power station.

The reservoir is linked to the turbines by a pipe of uniform cross-sectional area. Water flows from the reservoir, through the pipe and through the turbines at a constant rate.

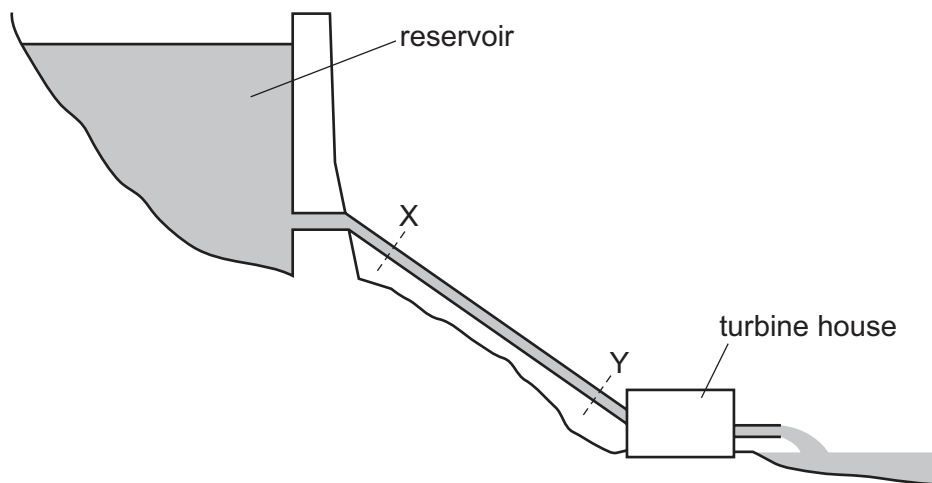

Which statement about the change of energy of the water as it moves from X to Y is correct?

- A It gains both gravitational potential energy and kinetic energy.
- B It loses gravitational potential energy and gains elastic potential energy.
- C It loses gravitational potential energy and gains kinetic energy.
- D It loses both elastic potential energy and gravitational potential energy.

Space for working

- 22 Which row correctly describes the ordering and motion of the molecules in water and in ice when both are at a temperature of 0°C ?

	ordering	motion
A	a regular pattern of molecules in ice but not in water	molecules in both ice and water have the same average speed
B	a regular pattern of molecules in ice but not in water	molecules in ice travel more slowly than those in water
C	a regular pattern of molecules in both ice and water	molecules in ice travel more slowly than those in water
D	a regular pattern of molecules in both ice and water	molecules in both ice and water have the same average speed

- 23 The diagram shows a rectangular block of mass 8.2kg immersed in sea water of density $1.10 \times 10^3\text{kg m}^{-3}$.

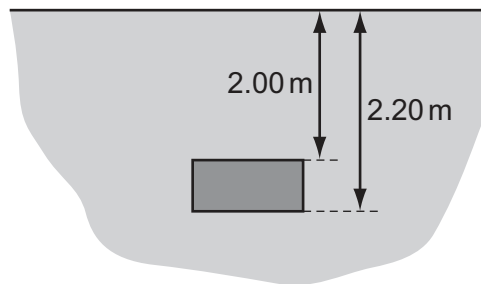

What is the difference in pressure between the top and bottom surfaces of the block?

- A** $2.2 \times 10^2\text{Pa}$
- B** $2.2 \times 10^3\text{Pa}$
- C** $1.8 \times 10^4\text{Pa}$
- D** $2.3 \times 10^4\text{Pa}$

Space for working

- 24 A trolley is held at rest between two steel springs.

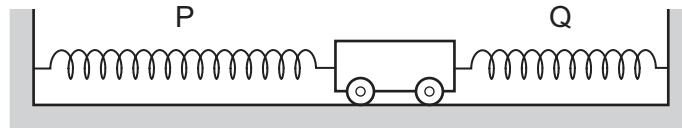

Each spring has an unstretched length of 0.10 m.

Spring P has spring constant 60 N m^{-1} .
Spring Q has spring constant 120 N m^{-1} .

Spring P has an extension of 0.40 m.

What is the extension of spring Q?

- A 0.10 m B 0.20 m C 0.30 m D 0.80 m
- 25 A lift is supported by two steel cables, each of length 10 m and diameter 0.5 cm.

The lift drops 1 mm when a man of mass 80 kg steps into the lift.

What is the best estimate of the value of the Young modulus of the steel?

- A $2 \times 10^{10} \text{ N m}^{-2}$
B $4 \times 10^{10} \text{ N m}^{-2}$
C $2 \times 10^{11} \text{ N m}^{-2}$
D $4 \times 10^{11} \text{ N m}^{-2}$

Space for working

- 26 The diagram shows an air-filled pipe open at both ends. The length of the pipe is 1.00 m and the lower surface of the inside of the pipe is covered with a layer of fine sand.

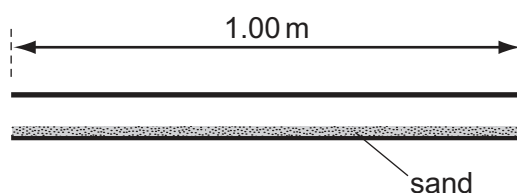

When a source of sound of a single frequency is put near one end of the pipe, the air in the pipe is found to resonate and a pattern in the sand shows that a standing wave containing three nodes is formed within the pipe.

The speed of sound in air is 330 m s^{-1} .

What is the frequency of the sound?

- A 330 Hz B 495 Hz C 990 Hz D 1320 Hz
- 27 A stationary sound wave is formed in a measuring cylinder by blowing across the top, as shown.



Which statement is correct?

- A The fundamental frequency of the stationary wave decreases when some water is added to the cylinder.
- B The stationary wave in the cylinder is caused by the superposition of two waves moving in opposite directions.
- C The stationary wave in the cylinder is polarised.
- D The stationary wave will have an antinode at the bottom of the cylinder.

Space for working

- 28 Diffraction can be observed when a wave passes an obstruction. The diffraction effect is greatest when the wavelength and the obstruction are similar in size.

For waves travelling through air, what is the combination of wave and obstruction that could best demonstrate diffraction?

- A microwaves passing a steel post
 - B radio waves passing a copper wire
 - C sound waves passing a human hair
 - D visible light waves passing a gate post
- 29 A health inspector is measuring the intensity of a sound. Near a loudspeaker, his meter records an intensity I . This corresponds to an amplitude A of the sound wave. At another position, the meter gives an intensity reading of $2I$.

What is the corresponding amplitude of the sound wave?

- A $\frac{A}{\sqrt{2}}$
- B $\sqrt{2}A$
- C $2A$
- D $4A$

Space for working

30 The diagram shows two parallel plates.

The plates are charged so that there is an electric field between them. P, Q and R are points which are $\frac{1}{4}$, $\frac{1}{2}$ and $\frac{3}{4}$ of the distance from the top plate to the bottom plate.

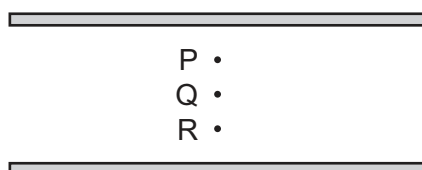

What is the electric field strength at point P?

- A the same as that at point Q
 - B twice that at point R
 - C half that at point R
 - D one third that at point Q
- 31 A positive charge of 2.6×10^{-8} C is in an electric field of constant field strength $300\,000$ V m⁻¹.

How much work must be done on the charge in order to move it a distance of 4.0 mm in the opposite direction to the direction of the field?

- A 3.1×10^{-5} J
- B 2.0×10^{-3} J
- C 3.1×10^{-2} J
- D 2.0 J

Space for working

32 Which values of current and resistance will produce a rate of energy transfer of 16 J s^{-1} ?

	current/A	resistance/ Ω
A	1	4
B	2	8
C	4	1
D	16	1

33 A copper wire is stretched so that its diameter is reduced from 1.0 mm to a uniform 0.5 mm.

The resistance of the unstretched copper wire is 0.2Ω .

What will be the resistance of the stretched wire?

- A** 0.4Ω **B** 0.8Ω **C** 1.6Ω **D** 3.2Ω

34 Four statements about potential difference or electromotive force are listed.

- 1 It involves changing electrical energy into other forms.
- 2 It involves changing other energy forms into electrical energy.
- 3 It is the energy per unit charge to move charge right round a circuit.
- 4 It is the work done per unit charge by the charge moving from one point to another.

Which statements apply to potential difference and which apply to electromotive force?

	potential difference	electromotive force
A	1 and 3	2 and 4
B	1 and 4	2 and 3
C	2 and 3	1 and 4
D	2 and 4	1 and 3

Space for working

35 The diagram shows a four-terminal box connected to a battery and two ammeters.

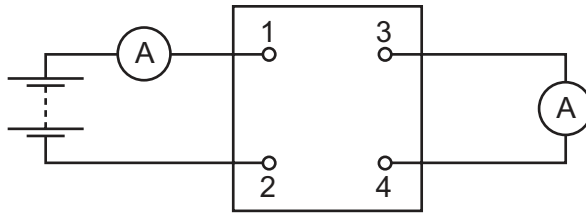

The currents in the two meters are identical.

Which circuit, within the box, will give this result?

A

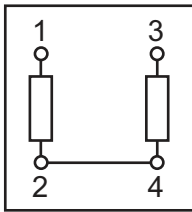

B

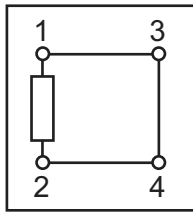

C

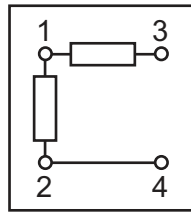

D

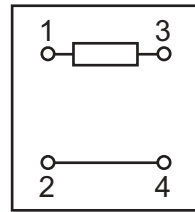

Space for working

- 36 In the circuit below, P is a potentiometer of total resistance 10Ω and Q is a fixed resistor of resistance 10Ω . The battery has an e.m.f. of 4.0V and negligible internal resistance. The voltmeter has a very high resistance.

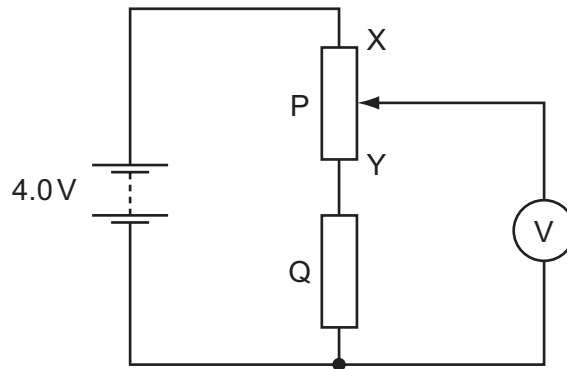

The slider on the potentiometer is moved from X to Y and a graph of voltmeter reading V is plotted against slider position.

Which graph is obtained?

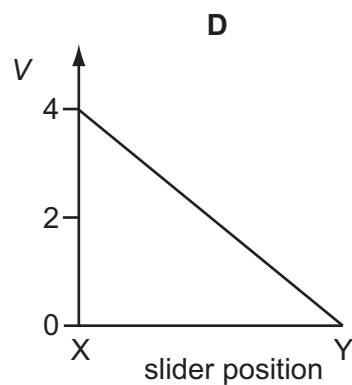
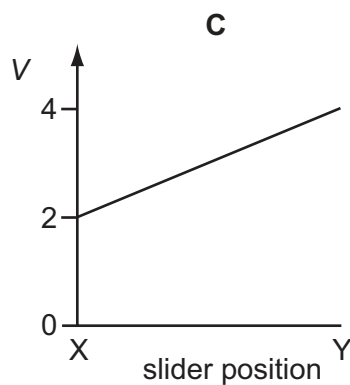
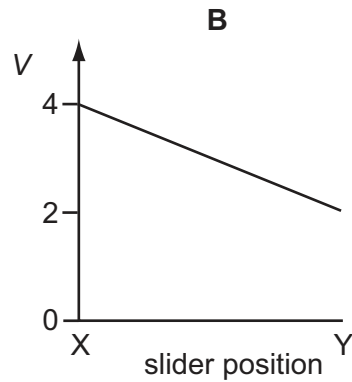
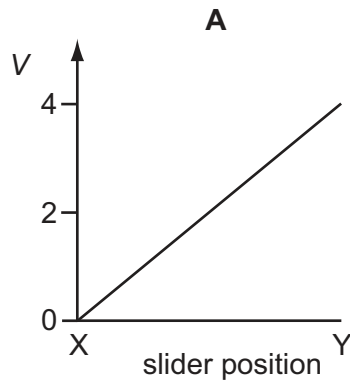

Space for working

37 The diagram shows a resistor network. The potential difference across the network is V .

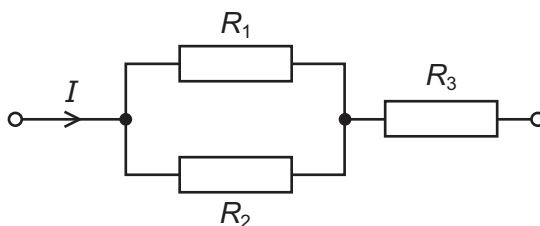

Is the equation shown below correct for the network?

$$V = I(1/R_1 + 1/R_2 + R_3)$$

- A Yes, it correctly combines two series resistors with one parallel resistor, and correctly uses Ohm's Law.
- B Yes, it correctly combines two parallel resistors with one series resistor, and correctly uses Ohm's Law.
- C No, because it should read $V = I \div (1/R_1 + 1/R_2 + R_3)$.
- D No, because the terms $1/R_2$ and R_3 have different units and cannot be added.

Space for working

- 38 A nuclear isotope emits radiation which is detected by a Geiger-Müller tube held at a distance of about 10 cm from the radioactive source. The radiation is stopped completely by a 2 mm thick sheet of lead.

What can be deduced from this information about the emission from the isotope?

- A It could be alpha and beta radiation, but not gamma radiation.
 - B It could be alpha and gamma radiation, but not beta radiation.
 - C It could be beta and gamma radiation, but not alpha radiation.
 - D It could be alpha, beta and gamma radiation.
- 39 What remains constant during β -emission from a number of identical nuclei in a substance?
- A energy of the β -particles
 - B neutron number of the nuclei
 - C nucleon number of the nuclei
 - D proton number of the nuclei

Space for working

- 40 The graph of neutron number against proton number represents a sequence of radioactive decays.

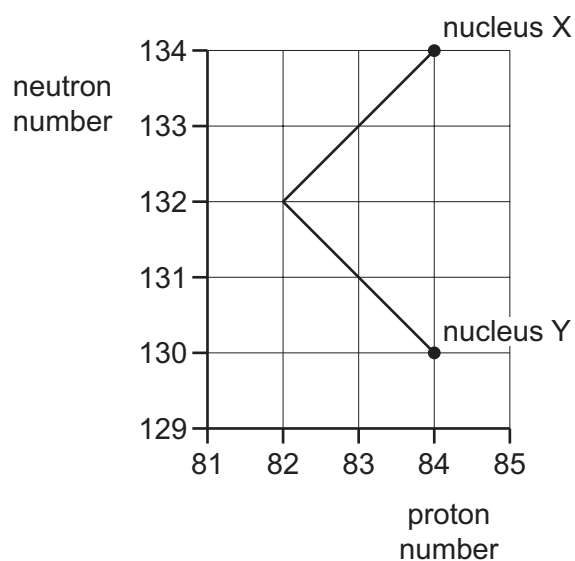

Nucleus X is at the start of the sequence and, after the decays have occurred, nucleus Y is formed.

What is emitted during the sequence of decays?

- A one α -particle followed by one β -particle
- B one α -particle followed by two β -particles
- C two α -particles followed by two β -particles
- D two β -particles followed by one α -particle

Space for working

BLANK PAGE

Permission to reproduce items where third-party owned material protected by copyright is included has been sought and cleared where possible. Every reasonable effort has been made by the publisher (UCLES) to trace copyright holders, but if any items requiring clearance have unwittingly been included, the publisher will be pleased to make amends at the earliest possible opportunity.

University of Cambridge International Examinations is part of the Cambridge Assessment Group. Cambridge Assessment is the brand name of University of Cambridge Local Examinations Syndicate (UCLES), which is itself a department of the University of Cambridge.